

PROJECT	_____
TYPE	_____
SPECIFIER	_____
QUANTITY	_____
DATE	_____

## BIONIQ EVO ROUND PINHOLE RECESSED

### A350216-

base number    Color Temperature    Finishes (Diamond)    Finishes (Triangle)    Beam Angle Options

- To build a product code in our configurator select the specify button on the base model # product page
- To build a manual product code on this datasheet choose from the options listed below in blue font and add the suffix to the base model #

#### GENERAL

Series: Bioniq Evo Round Pinhole  
 Partner: Prolicht  
 Division: Architectural  
 Installation: Recessed  
 Product Type: Downlight  
 Mounting Location: Ceiling  
 Light Distribution: Adjustable / Direct

#### PHYSICAL

Shape: Round  
 Diameter (mm): 83  
 Diameter (in): 3 1/4  
 Height (mm): 100  
 Depth (mm): 105  
 Height (in): 4  
 Depth (in): 4 1/8  
 Ceiling Thickness (mm): 2 - 20  
 Ceiling Thickness (in): 1/16 - 1 1/8  
 Weight (kg): 0.4  
 Fixture Finish: SSR / BKV / CWI / CRY / HAB / UFT / ITA / RUA / FTG / MYG / LOD / PUS / FRO / FUP / KIA / POP / BLS / SPG / MEY / GOH / CHC / COM / ABZ / JAG / OBR / MOS / ROR  
 Fixture Material: Extruded Aluminum  
 Cut-out Measurements: Ø 75mm/2 15/16"

#### ELECTRICAL

Lamp Type: LED (Zhaga Standard)  
 Input Wattage (W): 12.8  
 Total Output Wattage (W): 11.8  
 Dimming: Non-dimming / DALI Dimming / MATTER Dimming  
 Driver Included: No  
 Driver Location: Remote  
 Driver Type: Constant Current - Universal  
 Driver Class: Class 2  
 Constant Current (MA): 350mA  
 Upon Request: 0-10V Dimming / Phase Dimming

#### LED

Color Temperature (\*K): 2400 / 2700 / 3000 / 3500 / 4000  
 Max. Delivered Lumen (lm): Max 951  
 Nominal Lumen (lm): 2006  
 CRI: >90 CRI  
 Efficiency (%): 74.1  
 Lamp Life (hrs): 50000

#### OPTICAL

Beam Angle: 20 / 26 / 32  
 Adjustability: Rotational 350° / Tilt 30°

#### RATINGS AND CERTIFICATIONS

Certified By: Certified for North American Standards  
 IP rating: IP65  
 Glare Rating: ≤ 10

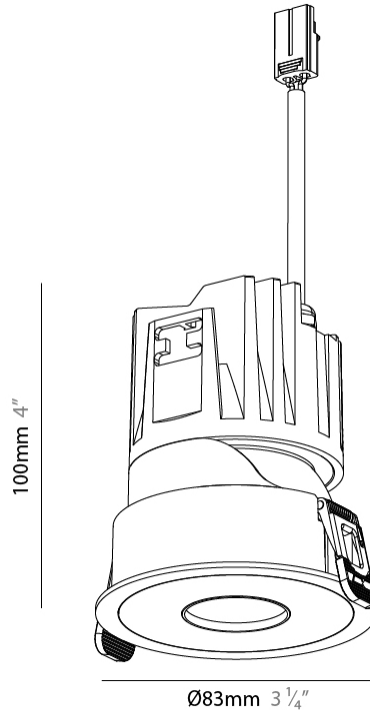

## BIONIQ EVO ROUND PINHOLE RECESSED

A350216-

PROJECT	_____
TYPE	_____
SPECIFIER	_____
QUANTITY	_____
DATE	_____

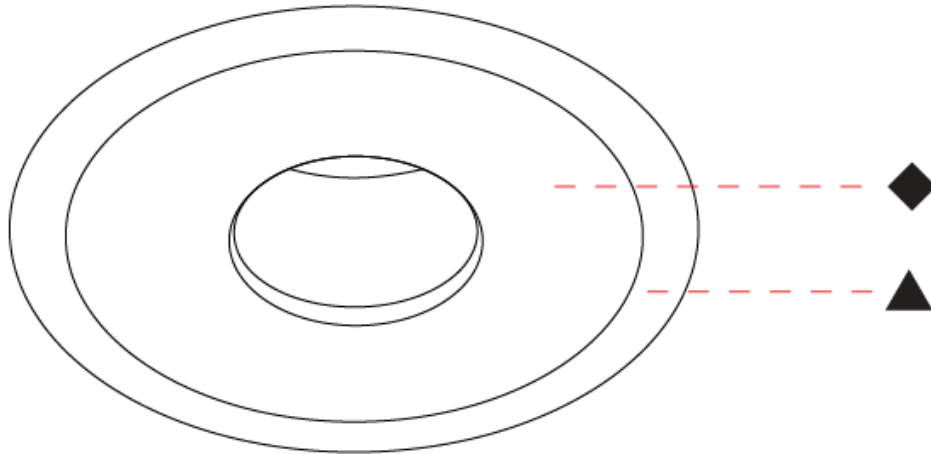

## BIONIQ EVO ROUND PINHOLE RECESSED

### A350217-

base number    Color    Finish    Beam Angle  
 Temperature    Options    Options

- To build a product code in our configurator select the specify button on the base model # product page
- To build a manual product code on this datasheet choose from the options listed below in blue font and add the suffix to the base model #

#### GENERAL

Series: Bioniq Evo Round Pinhole  
 Partner: Prolicht  
 Division: Architectural  
 Installation: Recessed  
 Product Type: Downlight  
 Mounting Location: Ceiling  
 Light Distribution: Adjustable / Direct

#### PHYSICAL

Shape: Round  
 Diameter (mm): 83  
 Diameter (in): 3 1/4  
 Height (mm): 100  
 Depth (mm): 105  
 Height (in): 4  
 Depth (in): 4 1/8  
 Ceiling Thickness (mm): 2 - 20  
 Ceiling Thickness (in): 1/16 - 1 1/8  
 Weight (kg): 0.4  
 Fixture Finish: [BLK / WHI](#)  
 Fixture Material: Extruded Aluminum  
 Cut-out Measurements: Dia. 75mm/2 15/16"

#### ELECTRICAL

Lamp Type: LED (Zhaga Standard)  
 Input Wattage (W): 12.8  
 Total Output Wattage (W): 11.8  
 Dimming: Non-dimming / DALI Dimming / MATTER Dimming  
 Driver Included: No  
 Driver Location: Remote  
 Driver Type: Constant Current - Universal  
 Driver Class: Class 2  
 Constant Current (MA): 350mA  
 Upon Request: 0-10V Dimming / Phase Dimming

#### LED

Color Temperature (°K): [2400 / 2700 / 3000 / 3500 / 4000](#)  
 Max. Delivered Lumen (lm): Max 951  
 Nominal Lumen (lm): 2006  
 CRI: >90 CRI  
 Efficiency (%): 74.1  
 Lamp Life (hrs): 50000

#### OPTICAL

Beam Angle: [20 / 26 / 32](#)  
 Adjustability: Rotational 350° / Tilt 30°

#### RATINGS AND CERTIFICATIONS

Certified By: Certified for North American Standards  
 IP rating: IP65  
 Glare Rating: ≤ 10

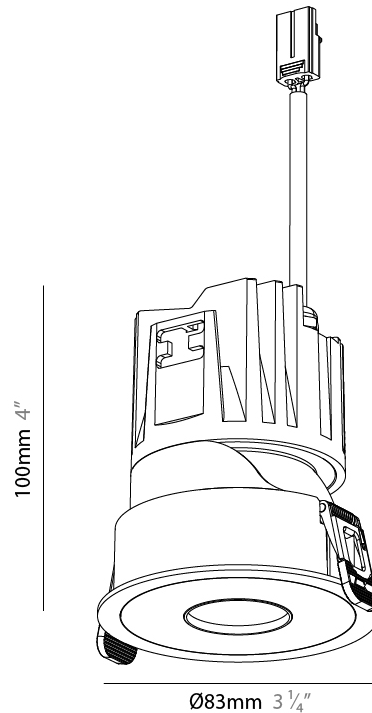
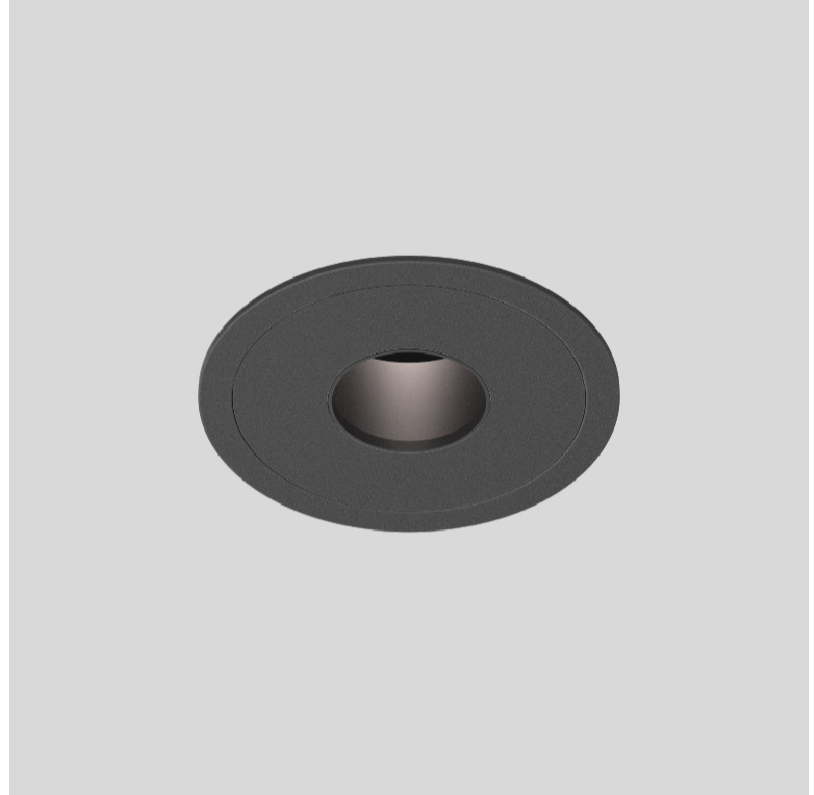

## BIONIQ EVO ROUND PINHOLE RECESSED

A350217-

PROJECT	_____
TYPE	_____
SPECIFIER	_____
QUANTITY	_____
DATE	_____

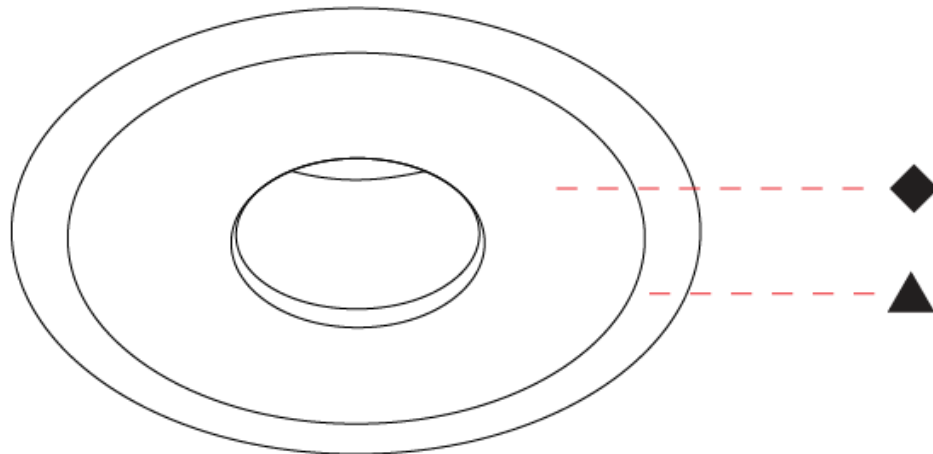

PROJECT	
TYPE	
SPECIFIER	
QUANTITY	
DATE	

## BIONIQ EVO ROUND PINHOLE RECESSED

### A350218-

base number	Color Temperature	Finishes (Diamond)	Finishes (Triangle)
-------------	----------------------	-----------------------	------------------------

- To build a product code in our configurator select the specify button on the base model # product page
- To build a manual product code on this datasheet choose from the options listed below in blue font and add the suffix to the base model #

#### GENERAL

Series: Bioniq Evo Round Pinhole
Partner: Prolicht
Division: Architectural
Installation: Recessed
Product Type: Downlight
Mounting Location: Ceiling
Light Distribution: Adjustable / Direct

#### PHYSICAL

Shape: Round
Diameter (mm): 83
Diameter (in): 3 1/4
Height (mm): 100
Depth (mm): 105
Height (in): 4
Depth (in): 4 1/8
Ceiling Thickness (mm): 2 - 20
Ceiling Thickness (in): 1/16 - 1 1/8
Weight (kg): 0.4
Fixture Finish: SSR / BKV / CWI / CRY / HAB / UFT / ITA / RUA / FTG / MYG / LOD / PUS / FRO / FUP / KIA / POP / BLS / SPG / MEY / GOH / CHC / COM / ABZ / JAG / OBR / MOS / ROR
Fixture Material: Extruded Aluminum
Cut-out Measurements: Ø 75mm/2 15/16"

#### ELECTRICAL

Lamp Type: LED (Zhaga Standard)
Input Wattage (W): 13
Total Output Wattage (W): 11.8
Dimming: Non-dimming / DALI Dimming / MATTER Dimming
Driver Included: No
Driver Location: Remote
Driver Type: Constant Current - Universal
Driver Class: Class 2
Constant Current (MA): 350mA
Upon Request: 0-10V Dimming / Phase Dimming

#### LED

Color Temperature (°K): 2400 / 2700 / 3000 / 3500 / 4000
Max. Delivered Lumen (lm): Max 698
Nominal Lumen (lm): Max 1231
CRI: >90 CRI
Efficiency (%): 53.8
Lamp Life (hrs): 50000

#### OPTICAL

Beam Angle: 10
Adjustability: Rotational 350° / Tilt 30°

#### RATINGS AND CERTIFICATIONS

Certified By: Certified for North American Standards
IP rating: IP65
Glare Rating: ≤ 10

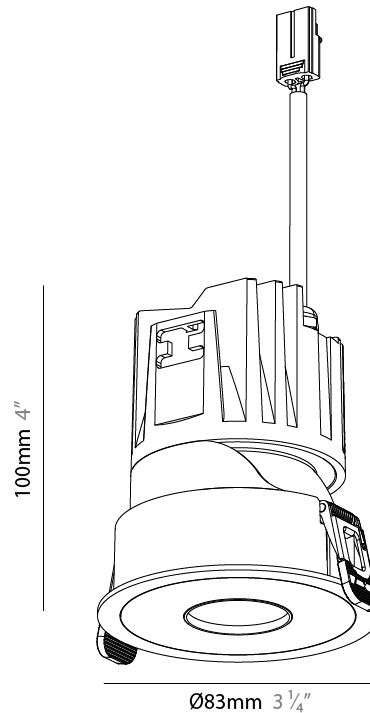
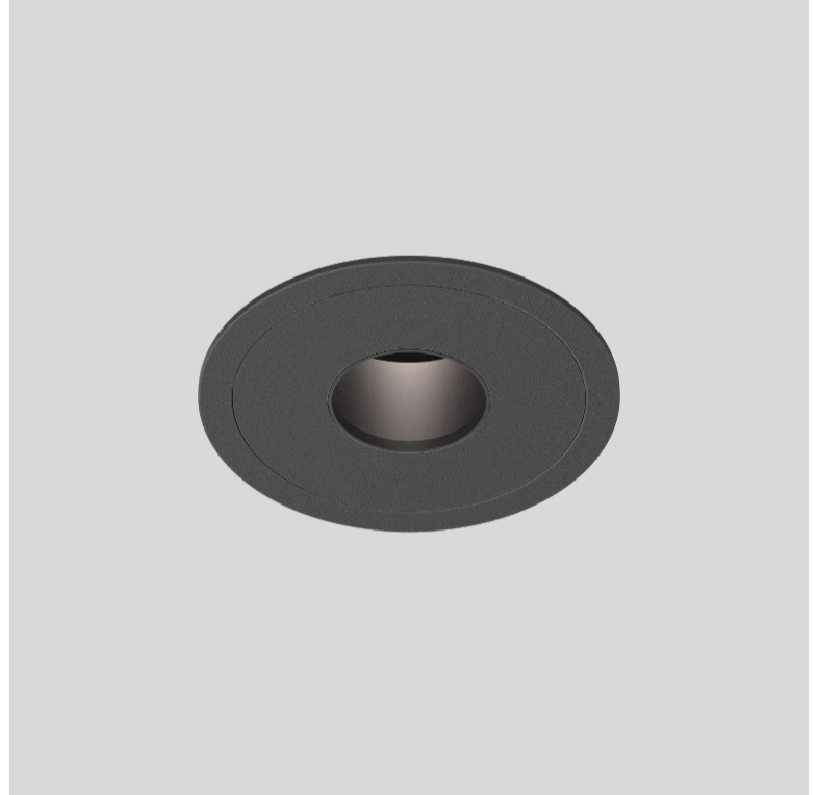

## BIONIQ EVO ROUND PINHOLE RECESSED

A350218-

PROJECT	_____
TYPE	_____
SPECIFIER	_____
QUANTITY	_____
DATE	_____

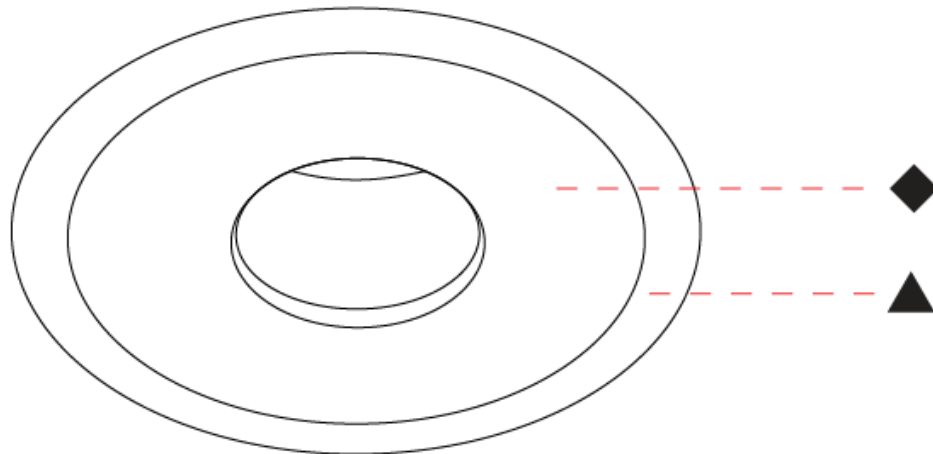

## BIONIQ EVO ROUND PINHOLE RECESSED

### A350219-

base number      Color      Finish  
 Temperature      Options

- To build a product code in our configurator select the specify button on the base model # product page
- To build a manual product code on this datasheet choose from the options listed below in blue font and add the suffix to the base model #

#### GENERAL

Series: Bioniq Evo Round Pinhole  
 Partner: Prolicht  
 Division: Architectural  
 Installation: Recessed  
 Product Type: Downlight  
 Mounting Location: Ceiling  
 Light Distribution: Adjustable / Direct

#### PHYSICAL

Shape: Round  
 Diameter (mm): 83  
 Diameter (in): 3 1/4  
 Height (mm): 100  
 Depth (mm): 105  
 Height (in): 4  
 Depth (in): 4 1/8  
 Ceiling Thickness (mm): 2 - 20  
 Ceiling Thickness (in): 1/16 - 1 1/8  
 Weight (kg): 0.4  
 Fixture Finish: [BLK / WHI](#)  
 Fixture Material: Extruded Aluminum  
 Cut-out Measurements: Dia. 75mm/2 15/16"

#### ELECTRICAL

Lamp Type: LED (Zhaga Standard)  
 Input Wattage (W): 13  
 Total Output Wattage (W): 11.8  
 Dimming: Non-dimming / DALI Dimming / MATTER Dimming  
 Driver Included: No  
 Driver Location: Remote  
 Driver Type: Constant Current - Universal  
 Driver Class: Class 2  
 Constant Current (MA): 350mA  
 Upon Request: 0-10V Dimming / Phase Dimming

#### LED

Color Temperature (°K): [2400 / 2700 / 3000 / 3500 / 4000](#)  
 Max. Delivered Lumen (lm): Max 698  
 Nominal Lumen (lm): Max 1231  
 CRI: >90 CRI  
 Efficiency (%): 53.8  
 Lamp Life (hrs): 50000

#### OPTICAL

Beam Angle: 20 / 26 / 32  
 Adjustability: Rotational 350° / Tilt 30°

#### RATINGS AND CERTIFICATIONS

Certified By: Certified for North American Standards  
 IP rating: IP65  
 Glare Rating: ≤ 10

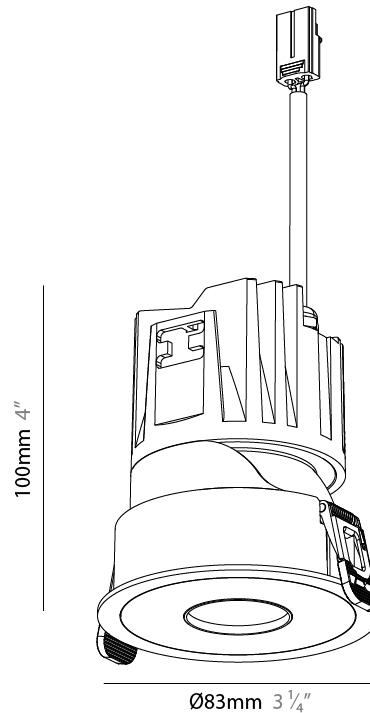
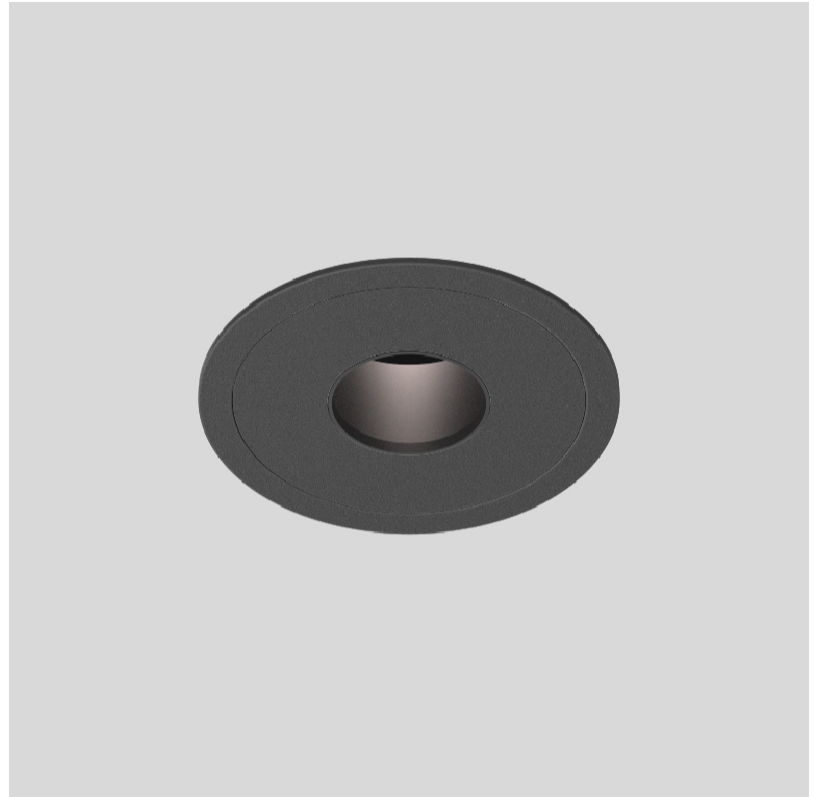

## BIONIQ EVO ROUND PINHOLE RECESSED

A350219-

PROJECT

TYPE

SPECIFIER

QUANTITY

DATE

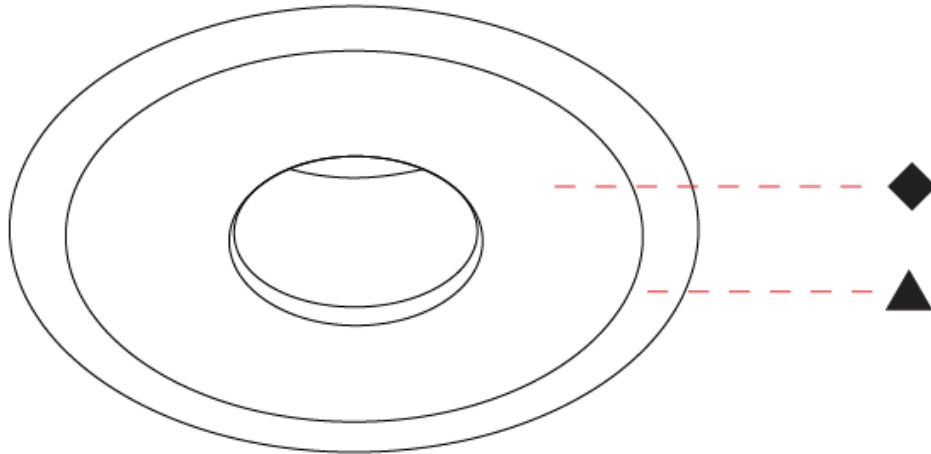

## BIONIQ EVO ROUND PINHOLE RECESSED

### A350221-

base number    Color    Finish    Beam Angle  
 Temperature    Options    Options

- To build a product code in our configurator select the specify button on the base model # product page
- To build a manual product code on this datasheet choose from the options listed below in blue font and add the suffix to the base model #

#### GENERAL

Series: Bioniq Evo Round Pinhole  
 Partner: Prolicht  
 Division: Architectural  
 Installation: Recessed  
 Product Type: Downlight  
 Mounting Location: Ceiling  
 Light Distribution: Adjustable / Direct

#### PHYSICAL

Shape: Round  
 Diameter (mm): 83  
 Diameter (in): 3 1/4  
 Height (mm): 100  
 Depth (mm): 105  
 Height (in): 4  
 Depth (in): 4 1/8  
 Ceiling Thickness (mm): 2 - 20  
 Ceiling Thickness (in): 1/16 - 1 1/8  
 Weight (kg): 0.4  
 Fixture Finish: [BLK / WHI](#)  
 Fixture Material: Extruded Aluminum  
 Cut-out Measurements: Dia. 75mm/2 15/16"

#### ELECTRICAL

Lamp Type: LED (Zhaga Standard)  
 Input Wattage (W): 12.3  
 Total Output Wattage (W): 10.9  
 Dimming: Non-dimming / DALI Dimming / MATTER Dimming  
 Driver Included: No  
 Driver Location: Remote  
 Driver Type: Constant Current - Universal  
 Driver Class: Class 2  
 Constant Current (MA): 350mA  
 Upon Request: 0-10V Dimming / Phase Dimming

#### LED

Color Temperature (°K): [2700-6500 Tunable White](#)  
 Max. Delivered Lumen (lm): Max 698  
 Nominal Lumen (lm): Max 1231  
 CRI: >90 CRI  
 Efficiency (%): 53.8  
 Lamp Life (hrs): 50000

#### OPTICAL

Beam Angle: [20 / 26 / 32](#)  
 Adjustability: Rotational 350° / Tilt 30°

#### RATINGS AND CERTIFICATIONS

Certified By: Certified for North American Standards  
 IP rating: IP65  
 Glare Rating: ≤ 10

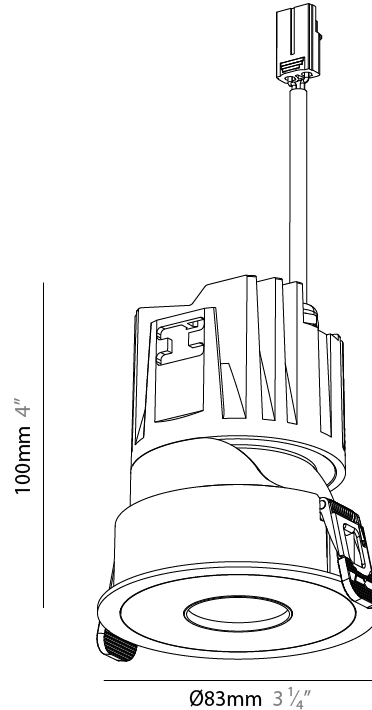
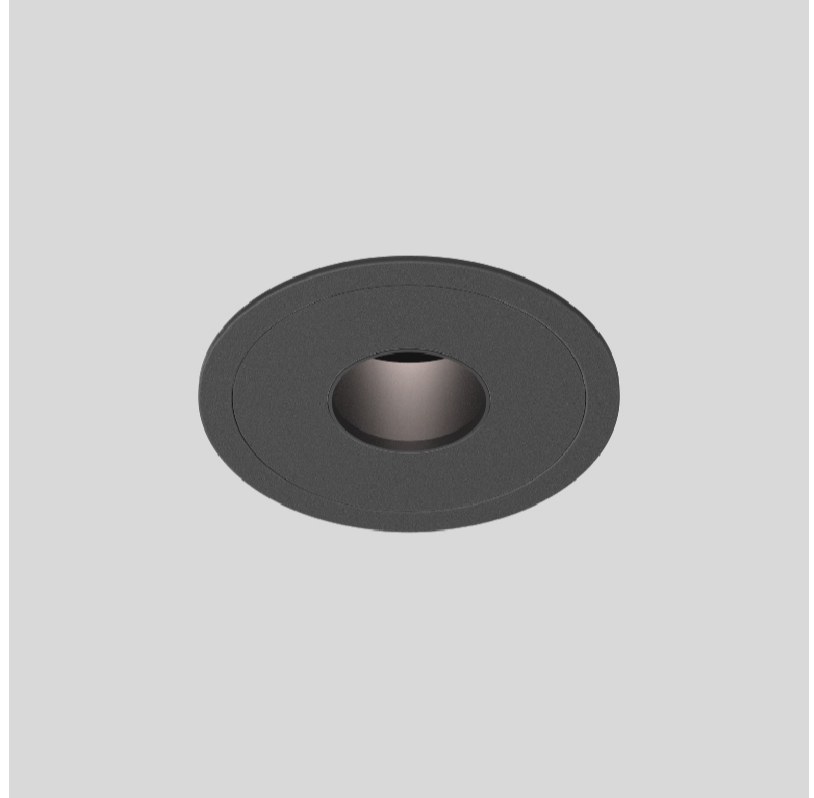

## BIONIQ EVO ROUND PINHOLE RECESSED

A350221-

PROJECT	_____
TYPE	_____
SPECIFIER	_____
QUANTITY	_____
DATE	_____

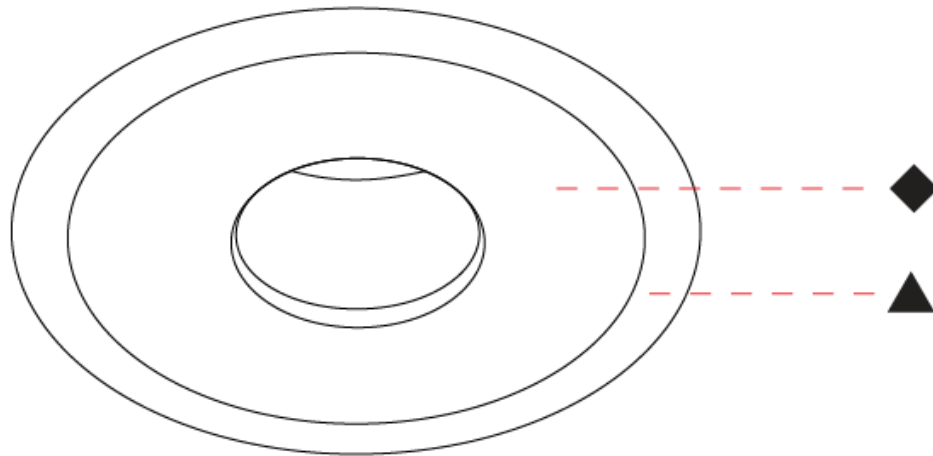

## BIONIQ EVO ROUND PINHOLE COLOR FINISH CHART

PROJECT
TYPE
SPECIFIER
QUANTITY
DATE

### Fixture Finish



**Digital:** Not all screens are calibrated the same, and therefore, colors will appear differently between screens.

**Physical:** When texture is involved, there will be variations in color, character and tone within a product series and between product families.











**Champagne Cream, Copper Mine, Ancient Bronze + Jazz Gold:** These finishes have slight fading from specific powder coating production. Each luminaire will slightly vary.













### LEGEND

	floor-mounted		pivotal		special LED (upon request) RGB, RGBW, tunable, gold+, meat+, art+, fashion+
	wall and ceiling: recessed and surface mounted		rotating		warm dim / natural dimming LED
	ceiling-mounted and wall-mounted		illuminate tilted		rechargeable battery powered
	wall-mounted		color of suspension cable		fixture with natural vivid LED (upon request)
	omni-directional light distribution		length of suspension cable		color rendering index
	direct light distribution		reflector degree selection		color temperature
	direct/indirect light distribution		super spot		lumen (luminous flux)
	indirect light distribution		lens		efficacy (lumens per watt)
	asymmetric light distribution		lens pack		Unified Glare Rating (UGR) range from 5-40
	aura light distribution		shine ring		marine grade (AISI 316 stainless steel)
	round wall or ceiling cut-out		integrated shine ring with diffuser		walk on
	square wall or ceiling cut-out		free individual colors 01-29		drive on
	the supplied jig specifies the cutout dimensions		individual colors: 00 (free of charge), 01-25 (extra charge)		Dark Sky Compliance
	minimum distance (meters) lamp - object		luminaire part to be colored (F1)		Americans with Disabilities Act (less than 4" off the wall located between 27"-84" from floor)
	recessed depth		luminaire part to be colored (F2)		lamp protected against explosion
	ceiling thickness in mm		luminaire part to be colored (F3)		blown glass using traditional methods by master glass blower
	ceiling thickness selection		luminaire part to be colored (F4)		acoustic material
	dimnable DP (phase), DV (0-10V), DD (dali), DS (step-dim)		luminaire part to be colored (F5)		protection class I, protection insulation
	included or excluded LED driver/transformer/control gear		color of 3-circuit adaptor		protection class II, protection insulation
	separately switchable		indirect diffuser		ETL Certified to UL and CSA Standards
	sensor		direct diffuser		UL Certified to UL and CSA Standards
	remote control		ball-proof (upon request)		CSA Certified to UL and CSA Standards
	available upon request		accessory		Certified for North American Standards

### IP RATING

	protected against ingress of solid bodies greater than 12.5mm (finger)
	protected against ingress of solid bodies greater than 2.5mm protected against sprays of water up to 60 degrees from the vertical (rain)
	protected against ingress of solid bodies greater than 1mm (wire) no protection against the ingress of moisture
	protected against ingress of solid bodies greater than 1mm (wire) protected against sprays of water up to 60 degrees from the vertical (rain)
	protected against ingress of solid bodies greater than 1mm (wire) protected against water splashed from all directions
	protected against limited ingress of dust (wet rooms/covered outdoor areas) protected against water splashed from all directions
	protected against ingress of dust protected against jets of water
	protected against ingress of dust protected against powerful jets of water or heavy seas
	protected against ingress of dust protected against immersion of water between 15cm - 1m for 30 minutes
	protected against ingress of dust protected against immersion of water under pressure for long periods

### IK RATING

	protected against 0.14 joules impact (equivalent to 0.25kg mass dropped from 56mm above the surface)
	protected against 0.2 joules impact (equivalent to 0.25kg mass dropped from 80mm above the surface)
	protected against 0.35 joules impact (equivalent to 0.25kg mass dropped from 140mm above the surface)
	protected against 0.5 joules impact (equivalent to 0.25kg mass dropped from 200mm above the surface)
	protected against 0.7 joules impact (equivalent to 0.25kg mass dropped from 280mm above the surface)
	protected against 1 joules impact (equivalent to 0.25kg mass dropped from 400mm above the surface)
	protected against 2 joules impact (equivalent to 0.5kg mass dropped from 400mm above the surface)
	protected against 5 joules impact (equivalent to 1.7kg mass dropped from 300mm above the surface)
	protected against 10 joules impact (equivalent to 5.0kg mass dropped from 200mm above the surface)
	protected against 20 joules impact (equivalent to 5.0kg mass dropped from 400mm above the surface)